



Model:
GP-170

GPS

Global Positioning System

Highly stable and reliable going ships, large yachts,

- ▶ Ideal position sensor for Radar, AIS, ECDIS, autopilot, echo sounder and other navigation and communications equipment
- ▶ Full compliance with IMO MSC. 112 (73) and IEC 61108-1: performance and testing standards for GPS receiver
- ▶ Newly designed GPS chip and antenna unit deliver enhanced stability and precision in position fixing
Enhanced noise rejection capabilities are incorporated in the GPS receiver chip, delivering anti-jamming function as well as high level of tolerance towards multi-path mitigation. Also, the tolerance towards multi-path mitigation is enhanced when GPA-020S or GPA-021S antenna unit is used.
- ▶ Augmentation to enhance precision by utilizing SBAS (Satellite-Based Augmentation System) and DGPS (an optional DGPS radio beacon receiver as well as GPA-021S antenna unit required)
- ▶ Fully complies with IMO MSC. 114 (73) and IEC 61108-4: performance and testing standards for DGPS radio beacon receiver
- ▶ 10 Hz position update rate (position updated every 0.1 second) making steady own ship position tracking possible
- ▶ USB port available on the front panel
Routing data, menu setting, user setting can be exported/imported through USB jump drives

- ▶ Dual configuration for back-up purpose to ensure system availability
Information about waypoints, route and other data set by the operators on the one unit can be shared with the other unit for functional back-up
- ▶ BAM (Bridge Alert Management) ready
Meets the specific requirements for alerts and interconnection with Bridge Alert Management in IMO MSC.302 (87)
- ▶ LAN interface available for efficient network integration into a bridge system
The GP-170 is fully Light Weight Ethernet (IEC 61162-450) compatible
- ▶ 5.7" color LCD (with 640 x 480 pixels) for data presentation
- ▶ Simplified menu operation
The operator can navigate through the menu tree either by pressing the cursor pad or pressing the corresponding numbers on the numeric keypad to the menu items
- ▶ Enhanced route planning/management function available
 - Comprehensive range of voyage information to be incorporated in routes
 - Streamlined route creation through combination with an external PC
 - Sharing the active route information with ECDIS to supplement the ECDIS route monitoring capability

▶ Variety of display modes available: Plotter, Course, Highway, Data and Integrity

- A** Basic positioning data such as own ship position data, its data integrity, time, etc., are presented. Also, display mode as well as notice icons are displayed.
- B** The area shows the information specific to the display mode currently selected. Please refer to each of the display modes for details.
- C** Guide to currently available actions is displayed. Under alert situation, the information about the most imminent alert is displayed.

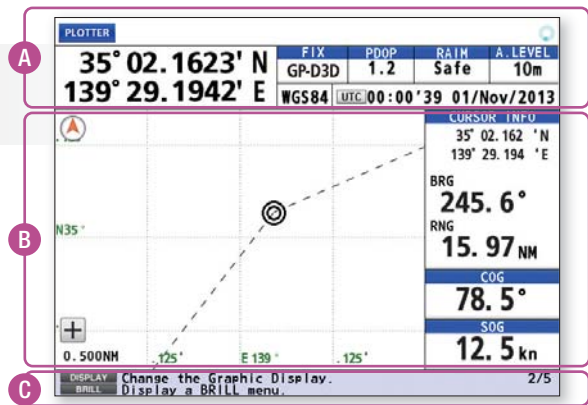

Interconnection Diagram

For new building

*Specify when ordering
**Selectable when DGPS beacon receiver is incorporated into the Display Unit GP-170.

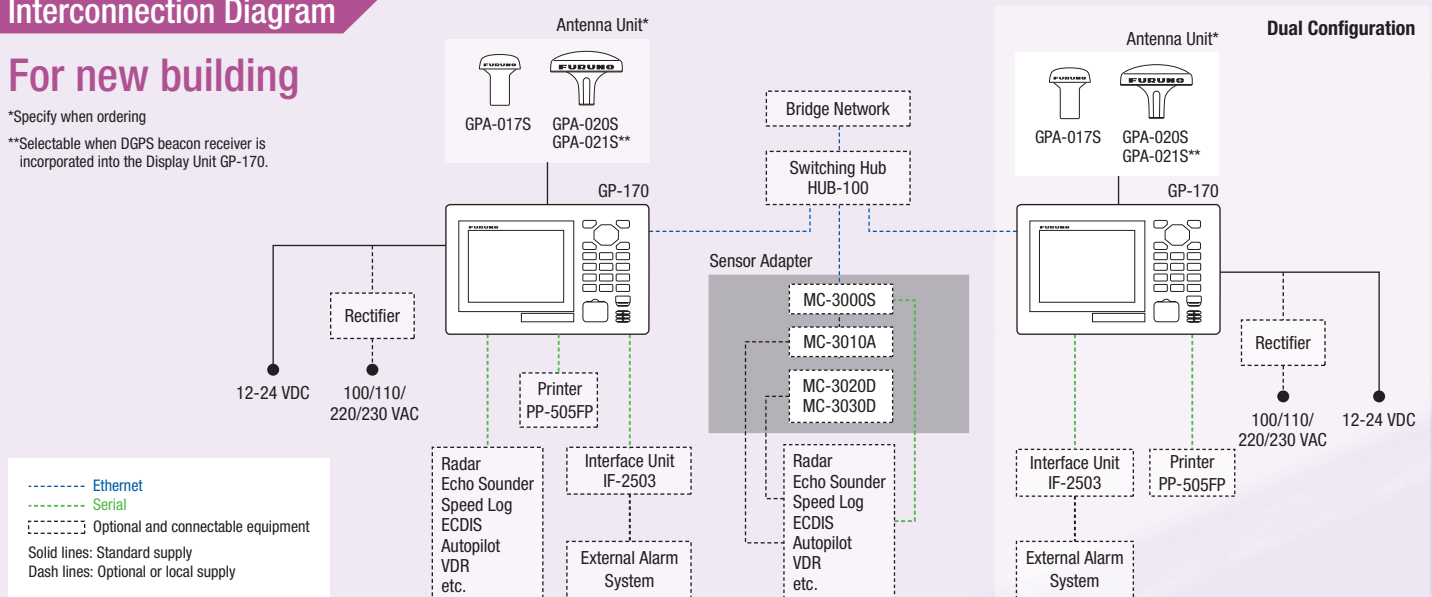

position fixing system for ocean ferries and commercial vessels



Plotter



Information to be displayed:

- ▶ Simplified plotter display
- ▶ Cursor information
- ▶ Contextual menu
- ▶ SOG/COG data boxes

Integrity



Information to be displayed:

- ▶ Skyplot presentation of currently viewable satellites
- ▶ Status on GNSS/SBAS satellite signal reception; incl. signal strength/signal to noise ratio (in bar/line charts)
- ▶ Elevation angles of the available satellites
- ▶ Detailed information about the beacon stations

Line chart presentation

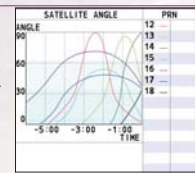

Line chart presentation shows the SNR and satellite angles for the past six hours.

Highway

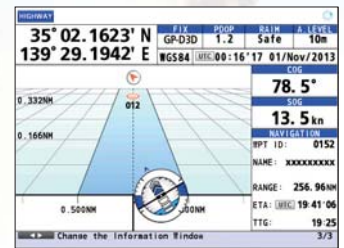

Information to be displayed:

- ▶ Course information
- ▶ SOG/COG data boxes
- ▶ User-preset cross track limit of deviation (XTE)
- ▶ Own ship gauge, showing the attitude of the ship, incl. pitch, roll and heave

Course

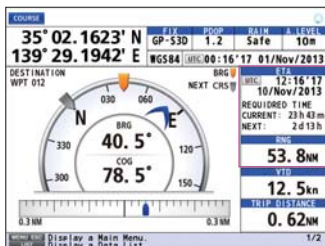

when autopilot is interfaced



MODE	Auto
HOG-AP	123.4°
RUDER	P023.4°
COURSE	123.4°
COG	13.5 kn

Information to be displayed:

- ▶ Graphical presentation of course information, incl. current waypoint, bearing to the destination, COG, XTE
- ▶ Estimated Time of Arrival data box, incl. required time to reach the current/next waypoints and range to the waypoint*
*when autopilot is interfaced, the following information is shown in the data boxes: Autopilot status data box, incl. mode, ship's heading, rudder angle, and COG, and SOG data box.
- ▶ Velocity to destination
- ▶ Trip distance data

Data

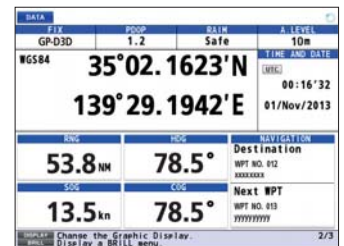

Information to be displayed:

- ▶ Navigation data boxes configurable according to the needs of the operators

For retrofitting

* Specify when ordering. The GPA-019S from the GP-150 previously installed can be used. If type-approved DGPS is required, please replace it with GPA-021S.

** Selectable when DGPS beacon receiver is incorporated into the Display Unit GP-170.

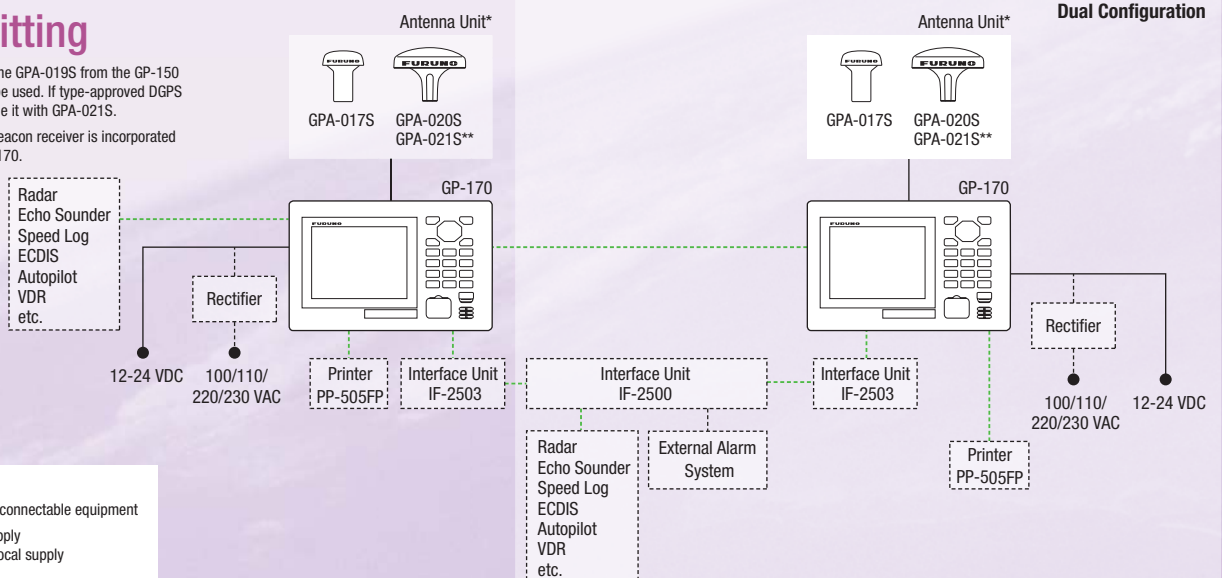

----- Serial
 [] Optional and connectable equipment
 Solid lines: Standard supply
 Dash lines: Optional or local supply

SPECIFICATIONS

Product Name

GPS NAVIGATOR

Receiver

Number of channels	GPS	12 ch
	SBAS	2 ch
RX frequency	GPS	1575.42 MHz±1.023 MHz
Tracking code	GPS	C/A
	SBAS	C/A
Accuracy*	GPS	not exceeding 10 m (2 drms, HDOP<4)
	DGPS	not exceeding 5 m (2 drms, HDOP<4)
	WAAS	not exceeding 3 m (2 drms, HDOP<4)
	MSAS	not exceeding 7 m (2 drms, HDOP<4)
Tracking velocity		1,000 kn
Position fixing time		90 sec when cold start
Position update rate		every 1 sec (standard); every 0.1 sec (max.)
Beacon receiver (optional internal kit)	Frequency range	283.5 to 325.0 kHz
	MSK rate	25, 50, 100, 150, 200 bps

* Dependent on ionospheric activity and multipath

Display Unit

Screen size	5.7" color LCD (116.16 mm x 87.12 mm)	
Resolution	640 (H) x 480 (V) pixels (VGA)	
Brightness	700 cd/m ²	
Display modes	Plotter, Highway, Course, Data, Integrity	
Plotter mode	Projection	Mercator
	Memory capacity	1,000 points for ship's track with comments up to 20 characters; 2,000 points for waypoints; 100 routes (containing up to 1,000 waypoints per 1 route)
Integrity mode	GNSS, Graph, Beacon	
Alert	Differential positioning interruption, HDOP overshoot, own ship positioning fail, own ship position lost, BEACON signal lost, BEACON malfunction, antenna short-circuit	
Notice	Arrival and anchor watch, XTE, Speed, Trip	
Integrity indication	Safe, Unsafe, Caution	

EQUIPMENT LIST

Standard	1. Display Unit	GP-170	1 unit
	2. Antenna Unit	GPA-017S	1 unit
		GPA-020S	1 unit
		GPA-021S*	1 unit
(specify when ordering)			
	* Selectable when a beacon receiver is incorporated into a display unit.		
	3. Antenna Cables	Selectable from 15 m/30 m/40 m/50 m	
	4. Installation Materials and Spare Parts		
Option	1. DGPS Receiver Kit	OP20-42	
	2. Antenna Cable	15 m/30 m/40 m/50 m	
	3. Network Cable	3 m with waterproof connector MOD-WPAS0001-030+	
	4. Flush Mount Kit	OP20-40/41	
	5. Antenna Base	NO. 13-QA330/NO. 13 QA310/NO. 13-RC5160	
	6. Interface Unit	IF-2503	
	7. Rectifier	PR-62, PR-240	

Display Unit

GP-170 (with an optional flush mount kit)

2.2 kg 4.9 lb (without DGPS beacon receiver)
2.4 kg 5.29 lb (with DGPS beacon receiver)

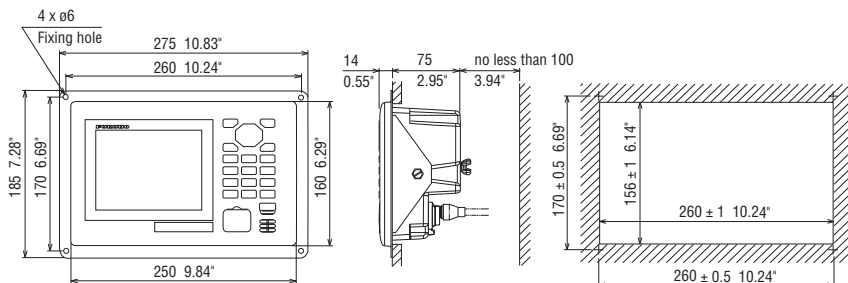

Antenna Unit

GPA-017S (for GPS)
0.12 kg 0.26 lb

GPA-020S (for GPS)
0.32 kg 0.71 lb

GPA-021S (for DGPS)
0.52 kg 0.15 lb

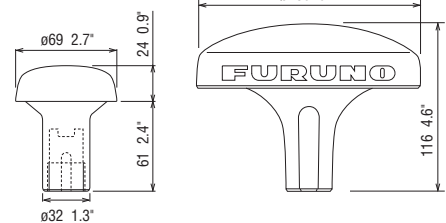

All brand and product names are registered trademarks, trademarks or service marks of their respective holders.
SPECIFICATIONS SUBJECT TO CHANGE WITHOUT NOTICE

FURUNO ELECTRIC CO., LTD.
Nishinomiya, Hyogo, Japan
www.furuno.com

FURUNO U.S.A., INC.
Camas, Washington, U.S.A.
www.furunousa.com

FURUNO (UK) LIMITED
Havant, Hampshire, U.K.
www.furuno.co.uk

FURUNO NORGE A/S
Ålesund, Norway
www.furuno.no

FURUNO DANMARK A/S
Hvidovre, Denmark
www.furuno.dk

FURUNO SVERIGE AB
Västra Frölunda, Sweden
www.furuno.se

FURUNO FINLAND OY
Espoo, Finland
www.furuno.fi

FURUNO POLSKA Sp. z o.o.
Gdynia, Poland
www.furuno.pl

FURUNO DEUTSCHLAND GmbH
Rellingen, Germany
www.furuno.de

FURUNO FRANCE S.A.S.
Bordeaux-Mérignac, France
www.furuno.fr

FURUNO ESPAÑA S.A.
Madrid, Spain
www.furuno.es

FURUNO ITALIA S.r.l.
Genoa, Italy

FURUNO HELLAS S.A.
Glyfada, Greece
www.furuno.gr

FURUNO (CYPRUS) LTD
Limassol, Cyprus
www.furuno.com.cy

FURUNO EURUS LLC
St. Petersburg, Russian Federation
www.furuno.com.ru

FURUNO SHANGHAI CO., LTD.
Shanghai, China
www.furuno.com/cn

FURUNO KOREA CO., LTD.
Busan, Korea
RICO (PTE) LTD
Singapore
www.rico.com.sg

14075SK Printed in Japan
Catalogue No. N-876b